



# Magnalock® Brackets & Accessories

## (IK) Installation Kit

Securiton's original Installation kit includes the following components:

SDG-1	Heavy Duty Drill Guide	TL-1	Threadlock
BPT-2	Blind Nut Placement Tool	COD-125	1/8" Cobalt Drill Bit
SB-1	Sex Bolt- 32/62/82	COD-375	3/8" Cobalt Drill Bit
SD-375	T-Handle Hex Wrench	CAD-375	3/8" Carbide Drill Bit
SEP-1	Hardware Pack- 62/82	HS-500	1/2" High Speed Drill Bit
SEP-2	Hardware Pack- 32	BN-250	Blind Nuts
RW-1	Rubber Washers	FC-1	Finish Caps
FW-1	Flat Washers	700-20095	Long Screw Pack
ICC-1	Insulated Crimpers	910-70050	Product Installation CD

IK Magnalock Installation Kit

## (IK2) Condensed Installation Kit

Just the essentials...

SDG-1	Heavy Duty Drill Guide
BPT-2	Blind Nut Placement Tool
TL-1	Threadlock
BN-250	Blind Nuts
910-70050	Product Installation CD

IK2 Magnalock Condensed Installation Kit



*The complete IK and IK2 kits offer substantial savings over purchasing the same items separately*

**NOTE:** All IK components are available separately (see price list)



## Offset Strikes

- Available for the 62, 68 and 82 Magnalocks
- Alters the position of the mounting hole by 1/4" [6mm]. This is often required to clear the glass on aluminum frame store front doors.

Part numbers shown here are for strikes ONLY.

AOS-62	Replacement 1/4" Offset Strike - M62, DM62 (X2), M68
AOS-82	Replacement 1/4" Offset Strike - M82



## Split Strikes

- Allow a single M32, M38, M62, M68 or M82 Magnalock to secure a double door at traffic control holding force level.

Part numbers shown here are for strikes ONLY.

ASS-32	Replacement Split Strike Set - M32, M38 (3" x 1.62" each side)
ASS-62	Replacement Split Strike Set - M62, M68 (3" x 2.75" each side)
ASS-82	Replacement Split Strike Set - M82 (4.25" x 2.75" each side)

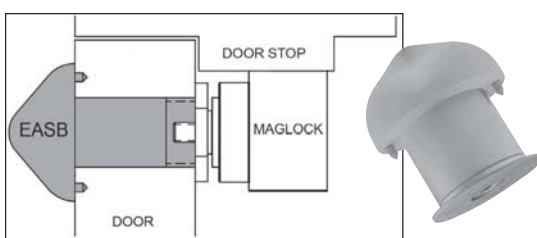

## (EASB) Energy Absorbing Sex Bolt

- For high security applications on inflexible doors
- Replaces the standard sex bolt
- Contains a powerful internal spring to absorb and dissipate the force of a blow

EASB-32	Sex Bolt, Energy Absorbing M32
EASB-62	Sex Bolt, Energy Absorbing M62/M68
EASB-82	Sex Bolt, Energy Absorbing M82

U.S. Patent:  
#5,578,913



## SB-1 Replacement Sex Bolt and TDK-1 Thick Door Kit

- Thick Door Kit for the SB-1 Sex Bolt (used on M32, M38, M62, M68 and M82B Magnalocks) allows the SB-1 to be used on doors thicker than 1-3/4" up to 3"

SB-1	Sex Bolt - Replacement, Clear
SB-1-03	Sex Bolt - Replacement, Polished Brass
SB-1-10B	Sex Bolt - Replacement, Oil Rubbed Bronze
TDK-1	Thick Door Kit



## (SWB) SAM Wood Bracket

- SAM Wood Door Bracket provides additional strength and protection for the SAM strike plate in wood door applications

SWB-26D	SAM Wood Door Bracket, Clear
SWB-10B	SAM Wood Door Bracket, Oil Rubbed Bronze
SWB-03	SAM Wood Door Bracket, Polished Brass

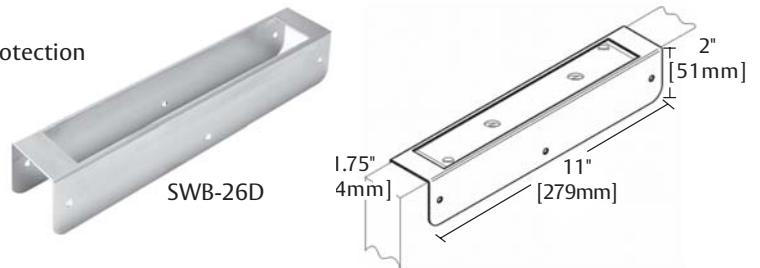

SWB finishes shown on page XX

## SAM Surface Mount Kit

- For specialty applications
- Permits the SAM magnet, strike, or both to be surface mounted when mortising is not possible
- Stainless Steel

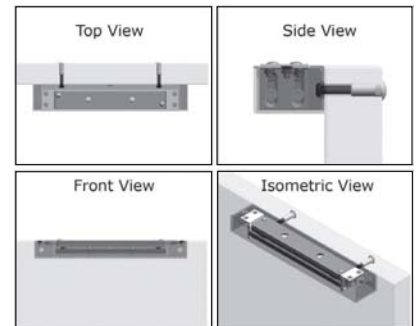

SMLS	Surface Mount Lock Housing
SMSS	Surface Mount Strike Housing

## Full Length Housings

- Vertical or horizontal configurations
- Fit one or two locks (not included)
- SLR = single left hand reverse
- SRR = single right hand reverse

HHD-32	Full Length Housing M32 Dbl. Horizontal
HHD-62	Full Length Housing M62 Dbl. Horizontal
HHD-82	Full Length Housing M82 Dbl. Horizontal
HHSL-32	Full Length Housing M32 SLR Horizontal
HHSL-62	Full Length Housing M62 SLR Horizontal
HHSL-82	Full Length Housing M82 SLR Horizontal
HHSR-32	Full Length Housing M32 SRR Horizontal
HHSR-62	Full Length Housing M62 SRR Horizontal
HHSR-82	Full Length Housing M82 SRR Horizontal
HVD-32	Full Length Housing M32 Dbl. Vertical
HVD-62	Full Length Housing M62 Dbl. Vertical
HVD-82	Full Length Housing M82 Dbl. Vertical

Vertical Housing

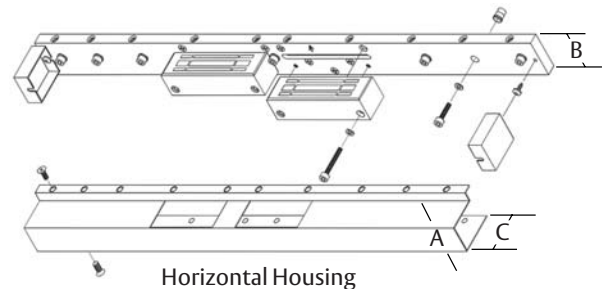

Horizontal Housing

Model	A	B	C	Max Length
HHD-32	1.75"	2.1"	2.35"	* - 96"
HHD-62	2.1"	2.6"	3.5"	* - 96"
HHD-82	2.1"	2.6"	3.5"	* - 96"

HHSL-32	1.75"	2.1"	2.35"	* - 48"
HHSL-62	2.1"	2.6"	3.5"	* - 48"
HHSL-82	2.1"	2.6"	3.5"	* - 48"

HHSR-32	1.75"	2.1"	2.35"	* - 48"
HHSR-62	2.1"	2.6"	3.5"	* - 48"
HHSR-82	2.1"	2.6"	3.5"	* - 48"

HVD-32	1.75"	2.1"	2.35"	* - 96"
HVD-62	2.1"	2.6"	3.5"	* - 96"
HVD-82	2.1"	2.6"	3.5"	* - 96"

"\*" indicates maximum available length

**NOTE:** Full length housings are individually made at the factory to customer specifications

Reference the table at right when ordering

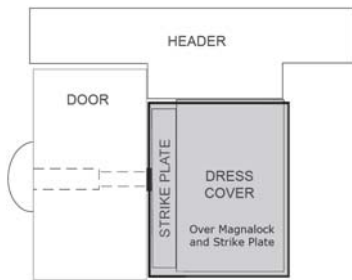

Dress Cover finishes shown on page 83

## (DC) Dress Covers

- Available for the M32, M38, M62, M68 and M82
- Install using foam adhesive
- M32, M62 and M82 available in four finishes

DC-32CL	Dress Cover	M32 Clear
DC-32BK	Dress Cover	M32 Black
DC-32SP	Dress Cover	M32 Stainless Polished
DC-32BP	Dress Cover	M32 Brass Polished
DC-38BK	Dress Cover	M38 Black
DC-38SP	Dress Cover	M38 Stainless Polished
DC-38BP	Dress Cover	M38 Brass Polished
DC-62CL	Dress Cover	M62 Clear
DC-62BK	Dress Cover	M62 Black
DC-62SP	Dress Cover	M62 Stainless Polished
DC-62BP	Dress Cover	M62 Brass Polished
DC-68BK	Dress Cover	M68 Black
DC-68SP	Dress Cover	M68 Stainless Polished
DC-68BP	Dress Cover	M68 Brass Polished
DC-82CL	Dress Cover	M82 Clear
DC-82BK	Dress Cover	M82 Black
DC-82SP	Dress Cover	M82 Stainless Polished
DC-82BP	Dress Cover	M82 Brass Polished



Dress Cover finishes shown on page 83

## (DDC) Double Dress Covers

- Available in two finishes
- Will cover a pair of Magnalocks on a double door (if they are separated by not more than 2")
- Not for use with the DM62 Magnalock

DDC-32CL	Double Dress Cover	M32 Clear
DDC-32BK	Double Dress Cover	M32 Black
DDC-62CL	Double Dress Cover	M62 Clear
DDC-62BK	Double Dress Cover	M62 Black
DDC-82CL	Double Dress Cover	M82 Clear
DDC-82BK	Double Dress Cover	M82 Black

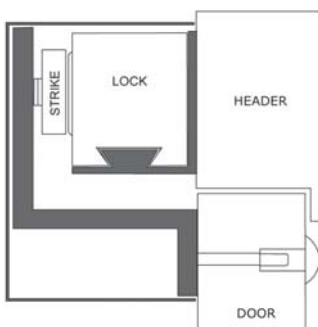

## (TJ) M38/M68 Inswing Door Kit - Top Jamb

- Used to mount the M38 or M68 lock on the secure side of a door that swings into a secured area
- Includes a Z Bracket and Dress Cover

TJ-38CL	Inswing Door Kit	M38 Clear
TJ-38BK	Inswing Door Kit	M38 Black
TJ-68CL	Inswing Door Kit	M68 Clear
TJ-68BK	Inswing Door Kit	M68 Black



## (ZA) Z Bracket Kits - Adjustable

- Used on inswing doors with the "F" type Magalock 8.5" overall length
- Provides 1" of lateral movement to accommodate most openings and allows for precision adjustments (2-1/16" to 3-1/16" from door/header)
- Includes a dress cover

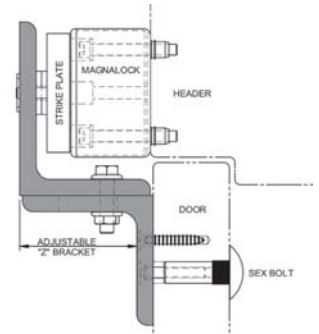

- ZA-32/62CL Adjustable Z Bracket M32/M62 Clear
- ZA-32/62BK Adjustable Z Bracket M32/M62 Black
- ZA-32/62SS Adjustable Z Bracket M32/M62 Stainless Steel
- ZA-82CL Adjustable Z Bracket M82 Clear
- ZA-82BK Adjustable Z Bracket M82 Black
- ZA-82SS Adjustable Z Bracket M82 Stainless Steel

## (Z) Z Bracket Kits - Fixed

- Used on inswing doors with the "F" type Magalock 8-3/8" length
- Includes a dress cover

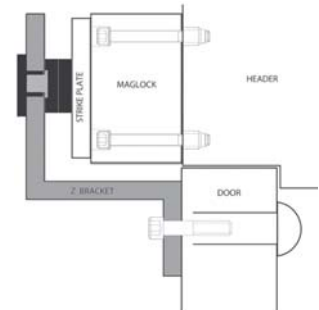

- Z-32CL Z-Bracket M32 Clear Cover
- Z-32BK Z Bracket M32 Black Cover
- Z-32SS Z Bracket M32 Stainless Steel Cover
- Z-62CL Z Bracket M62 Clear Cover
- Z-62BK Z Bracket M62 Black Cover
- Z-62SS Z Bracket M62 Stainless Steel Cover
- Z-82CL Z Bracket M82 Clear Cover
- Z-82BK Z Bracket M82 Black Cover
- Z-82SS Z Bracket M82 Stainless Steel Cover

## (ASB) Aluminum Spacer Bracket

- Used when a blade stop requires the Magalock to be lowered
- Comes pre-drilled (lock specific) for the mounting bolts and wire
- Provides a blind nut for surface installation of strike

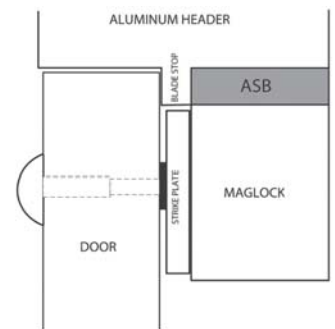

- ASB-32CL Alum Spacer Bracket M32 Clear - 8"
- ASB-32BK Alum Spacer Bracket M32 Black - 8"
- ASB-62CL Alum Spacer Bracket M62 Clear - 8"
- ASB-62BK Alum Spacer Bracket M62 Black - 8"
- ASB-82CL Alum Spacer Bracket M82 Clear - 12"
- ASB-82BK Alum Spacer Bracket M82 Black - 12"

## (UHB) Universal Header Bracket

- Use to extend the header from 1 to 1-1/2" inches
- Provides a concealed wiring chamber

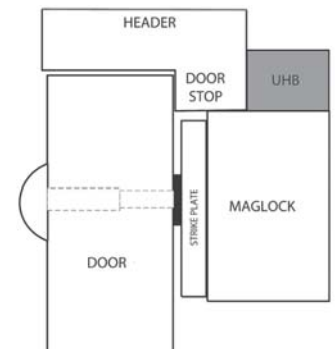

- UHB-CL-8 Universal Header Bracket Clear - 9-1/2"
- UHB-BK-8 Universal Header Bracket Black - 9-1/2"
- UHB-CL-12 Universal Header Bracket Clear - 13-1/2"
- UHB-BK-12 Universal Header Bracket Black - 13-1/2"

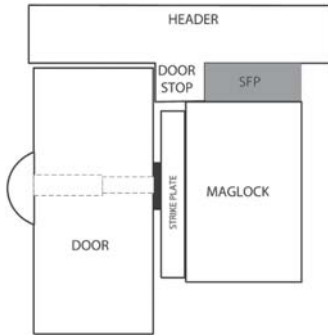

### (SFP) Stop Filler Plate

- Used to fill or extend a door stop
- Creates a flat mounting surface for the maglock
- Available in 1/4", 3/8", 1/2", and 5/8" inch thickness, all 1-1/4" wide

SFP-1/4CL-8	SFP 1/4" Clear - 8"	SFP-1/4CL-12	SFP 1/4" Clear - 12"
SFP-1/4BK-8	SFP 1/4" Black - 8"	SFP-1/4BK-12	SFP 1/4" Black - 12"
SFP-3/8CL-8	SFP 3/8" Clear - 8"	SFP-3/8CL-12	SFP 3/8" Clear - 12"
SFP-3/8BK-8	SFP 3/8" Black - 8"	SFP-3/8BK-12	SFP 3/8" Black - 12"
SFP-1/2CL-8	SFP 1/2" Clear - 8"	SFP-1/2CL-12	SFP 1/2" Clear - 12"
SFP-1/2BK-8	SFP 1/2" Black - 8"	SFP-1/2BK-12	SFP 1/2" Black - 12"
SFP-5/8CL-8	SFP 5/8" Clear - 8"	SFP-5/8CL-12	SFP 5/8" Clear - 12"
SFP-5/8BK-8	SFP 5/8" Black - 8"	SFP-5/8BK-12	SFP 5/8" Black - 12"

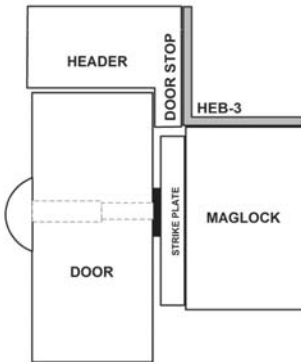

### (HEB) Header Extension Bracket

- 90 degree angle brackets
- Extends narrow headers to permit proper mounting of Magnalocks
- Available in clear aluminum or black anodized

HEB-3CL-8	Header Ext. Bracket 3" Clear - 8"
HEB-3BK-8	Header Ext. Bracket 3" Black - 8"
HEB-3CL-12	Header Ext. Bracket 3" Clear - 12"
HEB-3BK-12	Header Ext. Bracket 3" Black - 12"

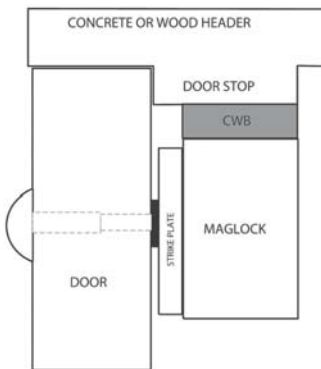

### (CWB) Concrete Wood Bracket

- Used on wood or concrete filled metal frames
- Provides a concealed wire chamber
- Easier than blind nuts in some cases

CWB-32CL	Concrete/Wood Bracket M32 Clear - 8"
CWB-32BK	Concrete/Wood Bracket M32 Black - 8"
CWB-62CL	Concrete/Wood Bracket M62 Clear - 8"
CWB-62BK	Concrete/Wood Bracket M62 Black - 8"
CWB-82CL	Concrete/Wood Bracket M82 Clear - 12"
CWB-82BK	Concrete/Wood Bracket M82 Black - 12"

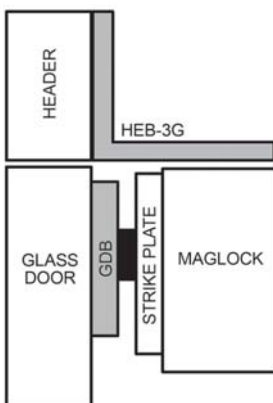

### (HEB-3G, GDB, AKG) Header Extension Bracket, Glass Door Bracket and Adhesive Kit

- HEB-3G allows for Magnalock installation on all-glass header (use with AKG below)
- Permits Magnalock installation on a solid glass door
- Permanently bonds to the glass with a special industrial adhesive
- Strike plate screws into the bracket, as glass doors cannot be drilled

HEB-3G	Header Extension Bracket M32/M62 Glass Door - 3" x 3" x 8"
GDB	Glass Door Bracket M32/38/62/68
AKG	Adhesive Kit (up to 10 applications)